

MADAM

M A L E T T I D E S I G N

IT EN 2023





chi è "MADAM"?

Madam è il nuovo furniture brand nato in casa Maletti. La cura per i dettagli e l'expertise del gruppo sono state direzionate verso una nuova sfida che guarda a un segmento di mercato con una visione più smart.

Madam ricrea nel salone un delizioso salotto informale: un piccolo spazio in cui prendersi cura dei clienti, arredato con stile e design.

Contemporanea e forte, Madam è una linea fuori dal coro. Creata per essere provocatoria, colorata e fashion, **Madam** è il tocco audace di Maletti group.

04

28

poltrone styling chair

TWIGGY	P. 4
GALA	P. 6
CARUSO	P. 8
MONIQUE	P. 10
JENNY	P. 12
KATY	P. 14
LIONESS	P. 16
LIONESS REC	P. 18

AFTER TOMORROW	P. 20
RING	P. 20
SIENA	P. 20
DOGE	P. 21

ZEUS EASY	P. 24
SIGMA	P. 26

lavatesta wash unit

LAZZARO	P. 30
GONDOLA PLUME	P. 32
LADY LION	P. 36
LADY KATY	P. 40
LADY CARUSO	P. 42
BAHAMAS	P. 44

Who is "MADAM"?

Madam is the new design brand created by Maletti.

The Maletti Team have used their expertise to look at the market and create a new range of furniture for today's salons.

Madam, recreates in the salon a delightful informal lounge, where clients can relax in an inviting and welcoming environment furnished with style.

Contemporary and strong, Madam looks at salon furniture from a new perspective.

Madam it is bold, fashion led, colourful and provocative.

46

mensole styling units

BUTTERFLY O	P. 48
BUTTERFLY B	P. 50
BUTTERFLY M	P. 52
TREVI / TREVI PLUS	P. 54
BRENTA	P. 56

58

mobili furnitures

BARBER STATION	P. 58
EASY M.	P. 60
TT	P. 66
GREAT	P. 66

62

reception cash desk

PANDORA SLIM	P. 62
QUADRA	P. 64

COME

IO



TWIGGY

5

34181C

↑ 780-890 mm ↗ 700 mm → 630 mm

Poltrona da lavoro girevole.
Struttura in poliuretano espanso da stampo
con inserto metallico.
Rivestimento in Skay a scelta.

Swivel styling chair.
Structure in moulded expanded
polyurethane with metal insert.
Skay upholstery to your choice.

Suggerito in abbinamento
Suggested in combination



008C	173C	585B	535B	563C
927C	918C	575B	921C	830B

CUSCINO OPTION/OPTIONAL CUSHION



3787 MADAM STAR



3786 MADAM RONDE

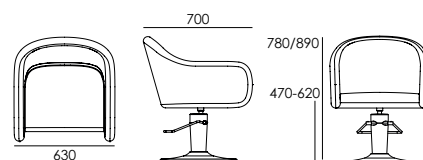

6



GALA

3421S STAR ALL IN ONE BOX
34121 RONDE ALL IN ONE BOX
 † 830-980 mm ↗ 605 mm → 665 mm

Poltrona da lavoro girevole.
 Struttura in poliuretano espanso da stampo con inserto metallico.
 Rivestimento in Sky nero.

Swivel styling chair.
 Structure in moulded expanded polyurethane with metal insert.
 Black Sky upholstery.

ONLY BLACK



MADAM STAR



MADAM RONDE

ALL IN ONE BOX

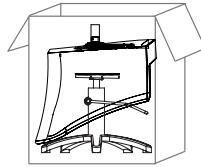

GALA 3421S

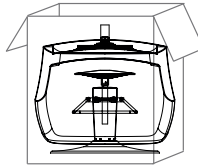

GALA 34121

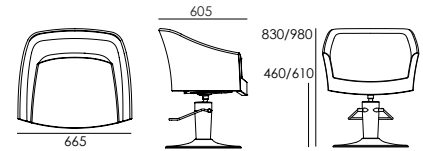



CARUSO

S34152MA (BLACK)
S34152CMA (COLOR)

↑ 880-990 mm ↗ 630 mm → 630 mm

Poltrona da lavoro girevole.
Struttura in poliuretano espanso
da stampo con inserto metallico.
Rivestimento in Skay

Swivel styling chair.
Structure in moulded expanded
polyurethane with metal insert.
Skay upholstery.



3787 MADAM STAR



3786 MADAM RONDE

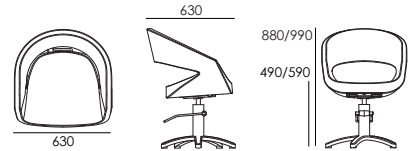

Suggerito in abbinamento
Suggested in combination



008C	173C	585B	535B	563C
927C	918C	575B	921C	830B







MONIQUE

11

33981MA (BLACK)

↑ 860-970 mm ↗ 615 mm → 650 mm

Poltrona da lavoro girevole.
Struttura in poliuretano espanso
da stampo con inserto metallico.
Rivestimento in Skay Nero

Swivel styling chair.
Structure in moulded expanded
polyurethane with metal insert.
Black Skay upholstery



3787 MADAM STAR



3786 MADAM RONDE

ONLY BLACK

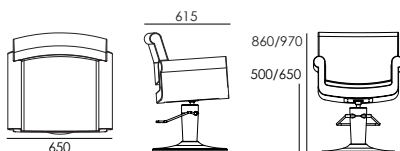



JENNY



3787 MADAM STAR



3786 MADAM RONDE

3381MA (COLOR)

↑ 790-900 mm ↗ 480 mm → 607 mm

Poltrona da lavoro girevole.
Struttura in poliuretano espanso da stampo con inserto metallico.
Rivestimento in Skay a scelta.

Swivel styling chair.
Structure in moulded expanded polyurethane with metal insert.
Skay upholstery to your choice.

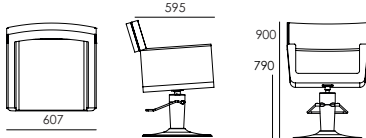

008C	173C	585B	535B	563C
927C	918C	575B	921C	830B



KATY

3219MA

↑ 880-1000 mm ↗ 600 mm → 585 mm

Poltrona da lavoro girevole.
Struttura in poliuretano espanso da stampo con inserto metallico, legno e plastica.
Braccioli in alluminio lucidato.
Rivestimento in Skay a scelta.

Swivel styling chair.
Structure in moulded expanded polyurethane with metal, wood and plastic.
Insert Polished aluminium armrests .
Skay upholstery to your choice.

Suggerito in abbinamento
Suggested combination



3787 MADAM STAR



3786 MADAM RONDE

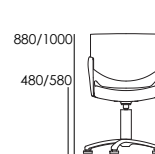

008C	173C	585B	535B	563C
927C	918C	575B	921C	830B







LIONESS

17

3365MA

↑ 840-950 mm ↗ 630 mm → 600 mm



3787 MADAM STAR



3786 MADAM RONDE

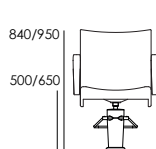
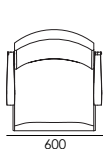

Poltrona da lavoro girevole.
Struttura in poliuretano espanso da stampo con inserto metallico e legno.
Braccioli in alluminio lucidato.
Rivestimento in Skay a scelta.

Swivel styling chair.
Structure in moulded expanded polyurethane with metal and wood insert.
Polished aluminium armrests.
Skay upholstery to your choice.

Suggerito in abbinamento
Suggested combination



008C	173C	585B	535B	563C
927C	918C	575B	921C	830B



3366MA



3787 MADAM STAR



3786 MADAM RONDE



APPCRO300A OPTIONAL

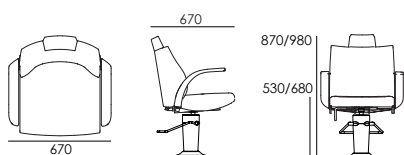

Sugerito in abbinamento
Suggested combination



↑ 870-980 mm ↗ 670 mm → 670 mm

Poltrona da lavoro girevole e reclinabile con appoggiatesta regolabile. Struttura in poliuretano espanso da stampo con inserto metallico e braccioli in alluminio lucidato. Rivestimento in Skay a scelta. Optional: appoggiapiedi

Swivel styling chair with adjustable headrest.

Structure in moulded expanded polyurethane with metal insert and polished aluminium armrests. Skay upholstery to your choice. Optional: Footrest

008C	173C	585B	535B	563C
927C	918C	575B	921C	830B



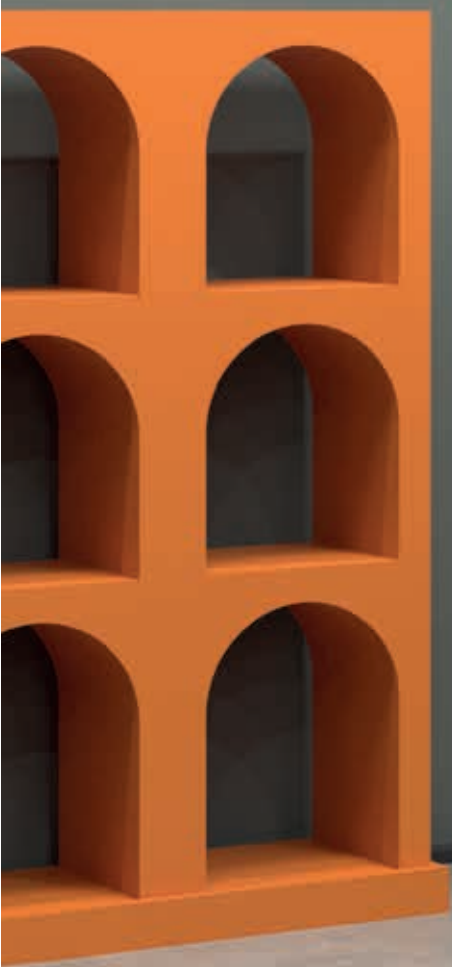

AFTER TOMORROW

3436MA

↑ 450-590 mm ↗ 420 mm → 395 mm

Sgabello girevole e regolabile in altezza con pompa a gas. Seduta in legno e poliuretano espanso da stampo. Base e pompa in acciaio cromato con ruote piroettanti. Rivestimento in Skay nero.

Swivel height adjustable stool with gas pump. Seat in wood and moulded expanded polyurethane. Chrome-finish steel base and pump with castors. Black Skay upholstery

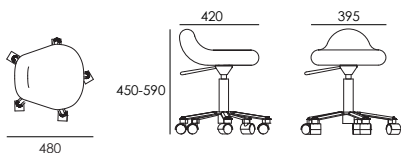

ONLY BLACK 008C
SPEEDY OPTIONAL



RING

3439MA

↑ 520-720 mm ↗ 375 mm → 375 mm

Sgabello girevole e regolabile in altezza con pompa a gas. Seduta in legno e poliuretano espanso. Base e pompa in acciaio cromato con ruote piroettanti. Rivestimento in Skay nero.

Swivel height adjustable stool with gas pump. Seat in wood and expanded polyurethane. Chrome-finish steel base and pump with castors. Black Skay upholstery

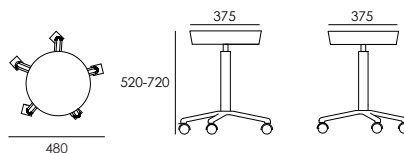

ONLY BLACK 008C
SPEEDY OPTIONAL



SIENA

3450MA

↑ 505-750 mm ↗ 340 mm → 380 mm

Sgabello girevole e regolabile in altezza con pompa a gas. Seduta in legno e poliuretano espanso da stampo. Base e pompa in acciaio cromato con ruote piroettanti. Rivestimento in Skay nero.

Swivel height adjustable stool with gas pump. Seat in wood and moulded expanded polyurethane. Chrome-finish steel base and pump with castors. Black Skay upholstery

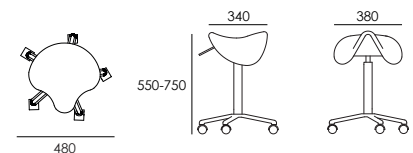

ONLY BLACK 008C
SPEEDY OPTIONAL



1 / 34621MA

↑ 800 mm ↗ 645 mm → 650 mm



Divanetto ad 1 posto
con cuscino asportabile
struttura in legno e poliuretano
rivestita in Skay nero e bianco.
Piedi in acciaio cromato.

Single sofa with removable cushion
structure in wood and polyurethane,
black and white Skay upholstery.
Chrome-finish steel feet.

2 / 34621MA

↑ 800 mm ↗ 645 mm → 1300 mm

Divanetto a 2 posti
con cuscino asportabile
struttura in legno e poliuretano
rivestita in Skay nero e bianco.
Piedi in acciaio cromato.

2 seater sofa with removable cushion
structure in wood and polyurethane,
black and white Skay upholstery.
Chrome-finish steel feet.

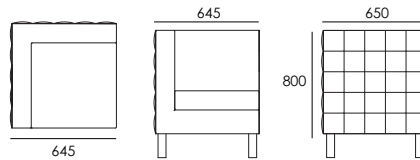







ZEUS EASY

25

34143MA (BLACK)
34143MAC (COLOR)

↑ 900-1080 mm ↗ 1180 mm → 710 mm

Poltrona da uomo girevole e reclinabile con pompa idraulica, appoggiatesta regolabile e appoggipiedi.

Struttura "heavy duty" e pedana in alluminio lucidato ad alta rigidità con ribaltina imbottita. Schienale, sedile, braccioli e gambale in poliuretano espanso. Pompa idraulica girevole e frenante.

Schienale reclinabile con movimento sincrono per alzagambe. Appoggiatesta regolabile ed estraibile. Imbottitura "Old Style" con supporto in molle in acciaio grecate per aumentare il comfort. Rivestimento in Skay con losanghe e piping.

Reclining swivel barber's chair with hydraulic pump, adjustable headrest and foot rest. Heavy duty structure and base in robust polished aluminium with upholstered flap. Polyurethane foam back, seat, armrests and leg rest. Hydraulic swivel pump with brake. Reclining backrest with synchronised leg lift movement. Adjustable, pull-out headrest. Old Style padding with corrugated steel springs for enhanced comfort. Skay diamond pattern upholstery with piping.

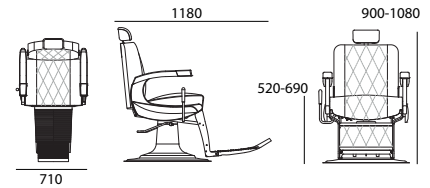

008C	173C	585B	535B	563C
927C	918C	575B	921C	830B



- 1 **POMPA IDRAULICA POTENZIATA**
Maletti utilizza solo pompe idrauliche potenziata così la poltrona rimane stabile anche in posizione reclinata.

BIGGER HYDRAULIC PUMP
Maletti uses only enhanced hydraulic pumps so the chair remains stable even in a reclined position.

- 2 **BASE**
Telaio in acciaio cromato e carter in alluminio.

BASE
Chromed steel frame and aluminium carter.

- 3 **MECCANISMO SINCRONO**
Grazie al meccanismo sincrono si ottiene una reclinazione totale della sedia, così il cliente può stendere le gambe sulla pedana ribaltabile imbottita.

SYNCHRONIZED MECHANISM
Thanks to the synchronous mechanism the chair is completely reclining, so the customer can stretch his legs on the padded footrest.

- 4 **APPOGGIATESTA**
Regolabile e rimovibile rivestito in Skay con telaio in acciaio.

HEADRESTS
Adjustable and removable, covered in Skay with steel frame.

SIGMA

302845MA

↑ 1000-1160 mm ↗ 1120 mm → 620 mm

Poltrona da uomo girevole e reclinabile con pompa idraulica, appoggiatesta regolabile e appoggipiedi.
Telaio in acciaio. Struttura sedile e schienale in poliuretano espanso da stampo con inserto in legno e metallo.
Pedana, gambale e braccioli in alluminio lucidato. Rivestimento in Skay a scelta.

Reclining swivel barber's chair with hydraulic pump, adjustable headrest and footrest.
Steel frame.
Seat and backrest structure in moulded polyurethane with wood and metal insert.
Polished aluminium tread plate, leg rest and armrests.
Skay upholstery to your preference.

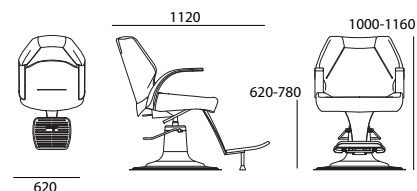

008C	173C	585B	535B	563C
927C	918C	575B	921C	830B



- 1 POMPA IDRAULICA POTENZIATA**
Maletti utilizza delle pompe idrauliche potenziata così la poltrona rimane stabile anche in posizione reclinata.

BIGGER HYDRAULIC PUMP
Maletti uses only enhanced hydraulic pumps so the chair remains stable even in a reclined position.

- 2 FINITURE DI PREGIO**
La poltrona è caratterizzata da un design sportivo e con finiture in alluminio di pregio.
Braccioli, cornice posteriore, gambale e pedana sono tutti pezzi in alluminio pressofuso lucidati a mano.

FINE FINISHES
The armchair is characterized by a sporty design and fine aluminum finishes.
In fact, armrests, back site, leg and footboard are all hand-polished and die-cast aluminum pieces.

- 3 APPOGGIATESTA**
Regolabile, rimovibile e rivestito in Skay con telaio in acciaio

HEADRESTS
Adjustable and removable, covered in Skay with steel frame.









LAZZARO FIX 45582008MA (BLACK)

LAZZARO FIX 45582CMA (COLOR)

Senza alzagambe Without leg lift

↑ 1010 mm ↗ 1310 mm → 645 mm

Lavatesta singolo e compatto con struttura interamente rivestita in sky, interni in legno multistrato rinforzato con telaio in acciaio zincato. Seduta e schienale ergonomici, gambale fisso oppure con alzagambe manuale. Vasca basculante ad elevata capacità. Retro lavaggio realizzato in ABS antigraffio colore nero. Predisposto per collegamento in serie con pre-scassi per passaggio tubi idraulici.

Compact single wash unit with structure fully upholstered in Sky, interior in reinforced plywood with galvanised steel frame. Ergonomic seat and backrest, fixed legrest. High capacity tipping basin. Wash unit back panel made in black scratch resistant ABS. Equipped for series connection with pre-cut holes for plumbing lines, optional leg lift.

Suggerito in abbinamento
Suggested combination



008C	173C	585B	535B	563C
927C	918C	575B	921C	830B

LAZZARO PLUS 45592008MA (BLACK)

LAZZARO PLUS 45592CMA (COLOR)

Con alzagambe manuale With manual leg lift

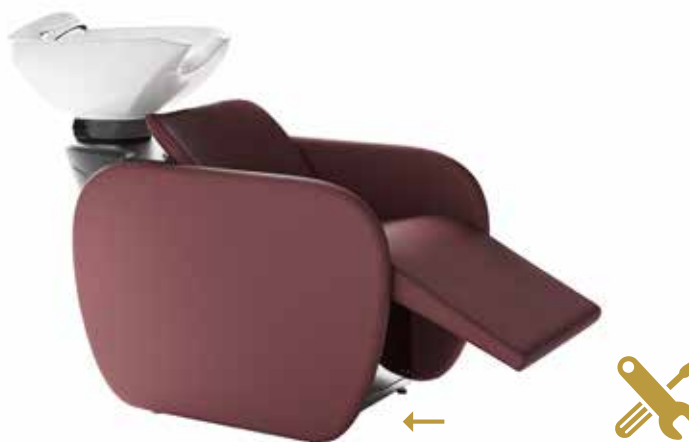

LAVATESTA ISPEZIONABILE

Lazzaro è un lavatesta ispezionabile frontalmente, fondamentale per la pulizia e la manutenzione.

INSPECTABLE WASH UNIT

Lazzaro can be inspected by lifting the front, essential for cleaning and maintenance.

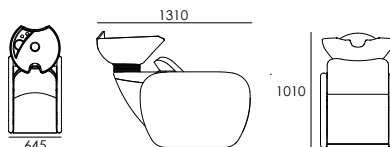

CUSCINO OPTION/OPTIONAL CUSHION





GONDOLA PLUME

GONDOLA PLUME FIX 4650 (BLACK)

GONDOLA PLUME FIX 4650C (COLOR)

Senza alzagambe / Without leg lift

↑ 1010 mm ↗ 1306 mm → 660 mm

GONDOLA PLUME COMFORT 4651 (BLACK)

GONDOLA PLUME COMFORT 4651C (COLOR)

Alzagambe elettrico / With electric leg lift

↑ 1010 mm ↗ 1653 mm → 660 mm

GONDOLA PLUME AIR MASSAGE 465 (BLACK)

GONDOLA PLUME AIR MASSAGE 465C (COLOR)

Alzagambe elettrico e massaggio ad aria / With electric leg lift and air massage

↑ 1010 mm ↗ 1653 mm → 660 mm

GONDOLA PLUME è il lavatesta con ingombro minimo grazie all'interasse ridotto a 65 cm. Struttura leggera autoportante in legno.

Carteratura posteriore di nuova generazione in alluminio con porta prodotti.

Doccetta con aeratore per risparmio garantito di acqua 6/7 litri al minuto contro 11/12 litri dei miscelatori standard. Scarico arretrato di 25 cm per favorire allacciamenti già esistenti, senza curve, facilitando il defluire dell'acqua. Tubo di scarico di diametro 40 con interno liscio per evitare residui all'interno.

GONDOLA è DISPONIBILE IN TRE MODELLI: AIR MASSAGE con alzagambe elettrico e massaggio ad aria, **COMFORT** con alzagambe elettrico senza massaggio **FIX** senza alzagambe e senza massaggio.

GONDOLA è abbinabile al SISTEMA VAPORE (Calotta Igloo + Vapomist).

Unicità del lavatesta: Seduta più confortevole ed ergonomica e ingombro minimo

- Carteratura posteriore di nuova generazione in alluminio colorato nero con porta prodotti - Telaio interno in legno - Ceramica di grande capacità che permette all'operatore di lavorare con maggiore comfort - Optional Piping a contrasto

GONDOLA PLUME: wash unit with minimal bulk thanks to the center distance reduced to 665 cm. Lightweight self-supporting wooden structure.

New generation aluminum rear casing with product holder.

Hand shower with aerator for guaranteed water saving, 6/7 liters per minute compared to the 11/12 liters of standard mixers. Evacuation recessed by 25 cm to facilitate existing connections, without elbows, to facilitate the flow of water. 40 diameter drain pipe with smooth interior to avoid residue inside.

GONDOLA IS AVAILABLE IN THREE MODELS: AIR MASSAGE with electric leg lift and air massage, **COMFORT** with electric leg lift without massage and **FIX** without leg lift and without massage. **The GONDOLA washing unit can be combined with the STEAM SYSTEM (Igloo shell + Vapomist).**

Uniqueness of the wash unit:

- More comfortable and ergonomic seat and minimal bulk - New generation aluminum black color, rear casing with product holder - Internal structure in wood.

- Large capacity ceramic that allows the operator to work with more comfort - Optional contrasting piping



008C	173C	585B	535B	563C
927C	918C	575B	921C	830B

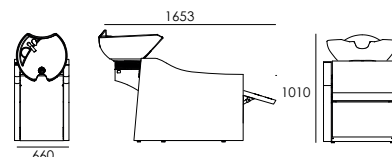

Suggerito in abbinamento
Suggested combination



stessa base
stessa codetta
la poltrona si
coordina col lavatesta
same base
same basin
the chair
coordinates with the
wash unit





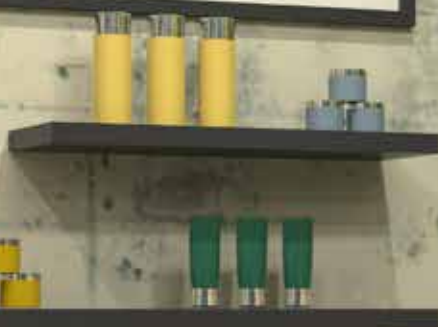

LADY LION

FIX 46272

↑ 1010 mm ↗ 1300 mm → 600 mm

Suggerito in abbinamento
Suggested combination



008C	173C	585B	535B	563C
927C	918C	575B	921C	830B

Lavatesta singolo
Basamento in plastica goffrata monoscocca a scelta grigio o nero. Codetta basculante in ceramica smaltata bianca con gruppo idraulico.
Sifone con filtro anti capelli.
Seduta Lioness, con inclinazione adeguata al lavatesta.
Colore a scelta.

Single wash unit. One-piece embossed plastic base, available in grey or black. Tipping white enamelled ceramic basin with hydraulic unit. Siphon with hair filter. Lioness seat with suitable inclination for the wash unit.
Skay covering, colour of your choice.



RAL 9005

RAL 7044

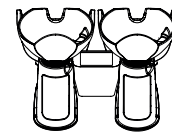
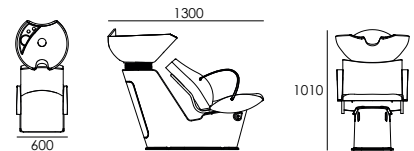

DETAILS (pag 81)

OPTIONAL / INFRA LADY 4117



LADY LION PLUS

46312

↑ 1010 mm ↗ 1315-1595 mm → 600 mm



RAL 9005

RAL 7044

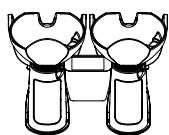
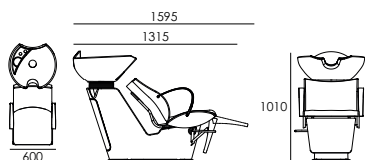

OPTIONAL / INFRA LADY 4117

Lavatesta singolo con basamento in plastica goffrata monoscocca a scelta grigio o nero.
Codetta basculante in ceramica smaltata bianca con gruppo idraulico.
Sifone con filtro anti capelli.
Seduta Lioness con inclinazione adeguata al lavatesta
Alzagambe manuale.
Rivestimento skay con colore a scelta.

Single wash unit.
One-piece embossed plastic base, available in grey or black.
Tipping white enamelled ceramic basin with hydraulic unit.
Siphon with hair filter.
Lioness seat with suitable inclination for the wash unit
Manual leg lift.
Skay covering, colour of your choice.

Sugerito in abbinamento
Suggested combination



008C	173C	585B	535B	563C
927C	918C	575B	921C	830B









RAL 9005

RAL 7044

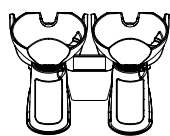
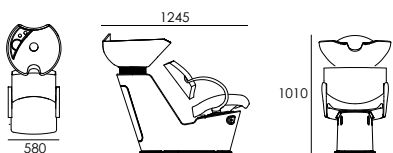

OPTIONAL / INFRA LADY 4117

FIX 46282

↑ 1010 mm ↗ 1245 mm → 580 mm

Lavatesta singolo con basamento in plastica goffrata monoscocca a scelta grigio o nero.
Codetta basculante in ceramica smaltata bianca con gruppo idraulico.
Sifone con filtro anti capelli.
Seduta: poltrona Katy con inclinazione adeguata al lavatesta.

Single wash unit.
One-piece embossed plastic base, available in grey or black.
Tipping white enamelled ceramic basin with hydraulic unit.
Siphon with hair filter
Katy seat with suitable inclination for the wash unit
Skay covering, colour of your choice.

Suggerito in abbinamento
Suggested combination



008C	173C	585B	535B	563C
927C	918C	575B	921C	830B



LADY CARUSO



FIX 46261N (BLACK)
FIX 46261 (COLOR)

↑ 1020 mm ↗ 1240 mm → 640 mm

Lavatesta singolo con basamento in plastica goffrata monoscocca a scelta grigio o nero.

Codetta basculante in ceramica smaltata bianca con gruppo idraulico.

Sifone con filtro anti capelli.

Seduta: poltrona Caruso con inclinazione adeguata al lavatesta. Rivestimento in Skay.

Single wash unit
 One-piece embossed plastic base, available in grey or black.

Tipping white enamelled ceramic basin with hydraulic unit.

Siphon with hair filter.

Caruso seat with suitable inclination for the wash unit. Skay upholstery.

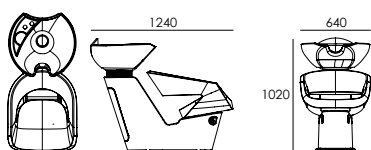

Suggerito in abbinamento
 Suggested combination

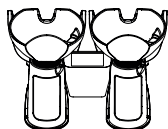

RAL 9005

RAL 7044

OPTIONAL / INFRA LADY 4117

008C	173C	585B	535B	563C
927C	918C	575B	921C	830B







BAHAMAS 4351MA

Senza alzagambe
Without leg lift

BAHAMAS PLUS 4352MA

Con alzagambe manuale
With manual leg lift

↑ 1010 mm ↗ 1285 mm → 630 mm

Lavatesta singolo con basamento in acciaio inox lucido.
Codetta basculante in ceramica smaltata bianca con gruppo idraulico. Sifone con filtro anti capelli.
Seduta poltrona Lioness con inclinazione adeguata al lavatesta, struttura interna in poliuretano espanso con inserto metallico e braccioli in alluminio lucidato.
Rivestimento in Skay con colore a scelta.
Disponibile senza alzagambe e con alzagambe manuale.

Single wash unit with base in polished stainless steel.
Tilting white ceramic glazed tail with hydraulic unit. Siphon with anti-hair filter.
Lioness seat with suitable inclination for the wash unit, internal structure in polyurethane foam with metal insert and armrests in polished aluminum.
Skay covering, colour of your choice.
Available without leg rests and with manual leg lift.



senza alzagambe
without leg lift



alzagambe manuale a leva
leg lift manual lever

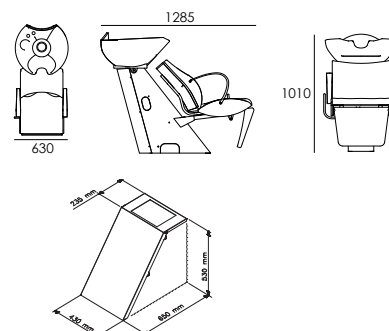

OPTIONAL / INFRABAHAMAS 410801600

008C	173C	585B	535B	563C
927C	918C	575B	921C	830B

Suggerito in abbinamento
Suggested combination









BUTTERFLY O

49

1530

↑ 1900 mm ↗ 225 mm → 800 mm

Mensola salone corredata da specchio. Telaio portante in legno nobilitato bordato a specchio. Specchio con molatura su perimetro. Pianetto in acciaio verniciato con foro portaphon.

Salon styling unit with mirror and shelf. Frame in wood veneer with mirror finish edging. Wall mounted. Painted steel shelf with hair drier holder

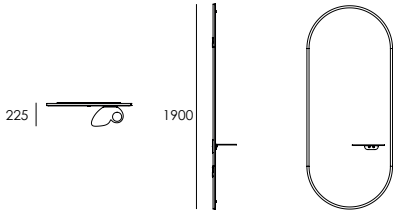

OPTION /1533

Mobile expo retro mensola
Back storage



GOLD WHITE



BUTTERFLY B

1532

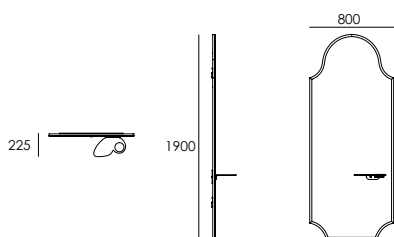

↑ 1900 mm ↗ 225 mm → 800 mm

Mensola salone corredata da specchio.
 Telaio portante in legno nobilitato bordato a specchio.
 Specchio con molatura su perimetro.
 Pianetto in acciaio verniciato con foro portaphon.

Salon styling unit with mirror and shelf.
 Frame in wood veneer with mirror finish edging.
 Wall mounted.
 Painted steel shelf with hair drier holder.



OPTION /1533

Mobile expo retro mensola
 Back storage



GOLD WHITE







BUTTERFLY M

53

1531

↑ 1900 mm ↗ 225 mm → 800 mm

Mensola salone corredata da specchio
Telaio portante in legno nobilitato
bordato a specchio.
Specchio con molatura su perimetro
Pianetto in acciaio verniciato
con foro portaphon.

Salon styling unit with mirror and shelf.
Frame in wood veneer
with mirror finish edging.
Wall mounted.
Painted steel shelf with hair drier holder

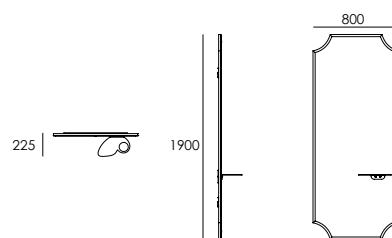

OPTION /1533

Mobile expo retro mensola
Back storage

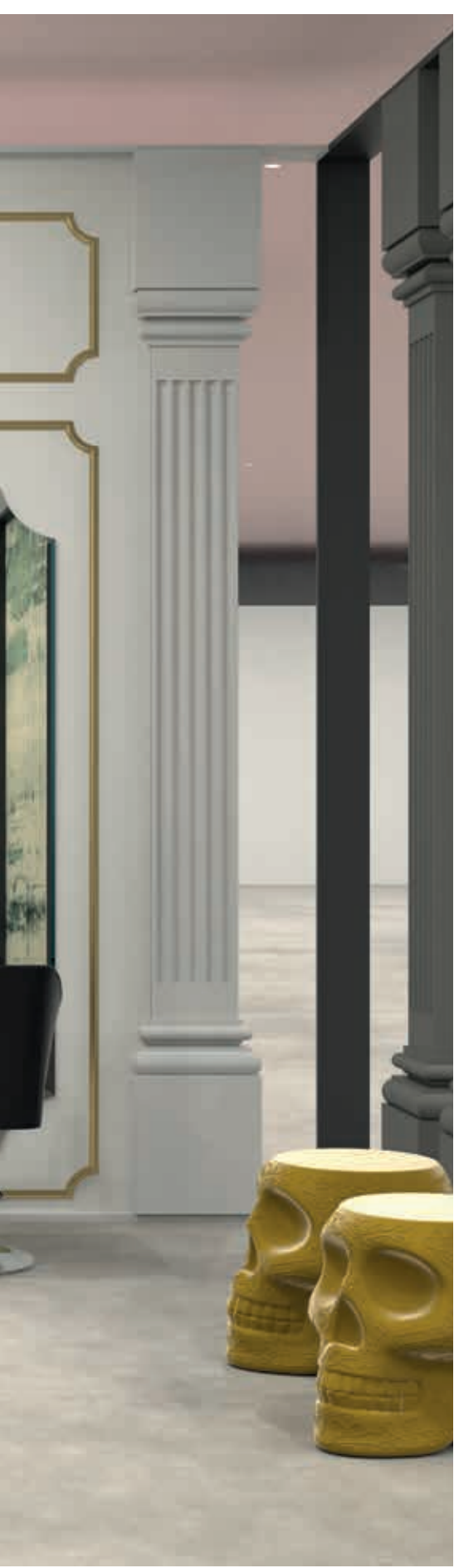

GOLD WHITE

TREVI PLUS 1552MA

↑ 2075 mm ↗ 285 mm → 962,5 mm

Mensola salone corredata da specchio.
 Telaio portante in metallo verniciato.
 Cornice in estruso di alluminio lucidato
 Specchio. Pianetto in pressofusione di alluminio lucidato.
 Appoggiapiede in metallo cromato

Salon styling mirror with shelf.
 Painted metal frame.
 Polished extruded aluminium surround.
 Mirror. Polished cast aluminium shelf.
 Chrome-finish metal footrest.

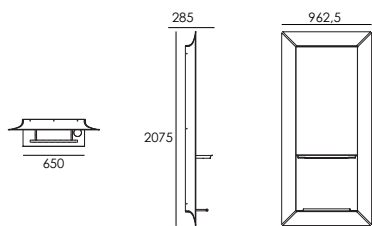

TREVI EASY 1549MA

↑ 2075 mm ↗ 112 mm → 962,5 mm

Mensola salone corredata da specchio
 Telaio portante in metallo verniciato.
 Cornice in estruso di alluminio lucidato .
 Specchio.

Salon styling mirror with shelf.
 Painted metal frame.
 Polished extruded aluminium surround.
 Mirror.

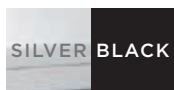
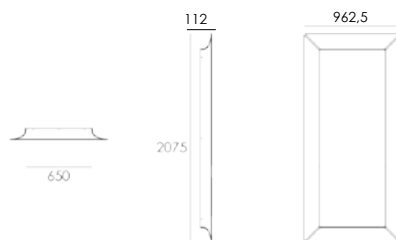





BRENTA

57

1512MA

↑ 2400 mm ↗ 250 mm → 650 mm

Specchiera a parete singola.
Struttura in acciaio.
Piano in alluminio con foro porta phon.

Single wall mirror.
Steel frame.
Aluminium shelf with hair drier holder.

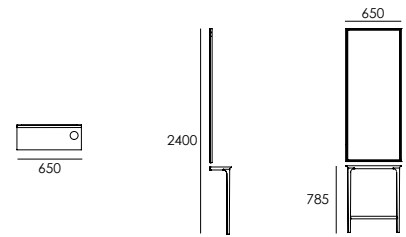



BARBER STATION

59

P4345

↑ 2000 mm ↗ 500 mm → 1500 mm

Composizione barber station:
struttura in nobilitato idrofugo
colore engandina o sequoia.

Barber station composition:
water-repellent melamine structure
color engandine or redwood.

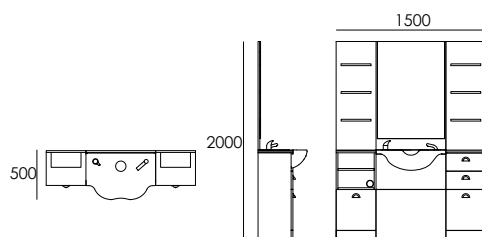

FINITURE DI RIVESTIMENTO COATING FINISHES



LAVABO BIANCO O NERO WHITE OR BLACK WASHBASIN



EASY M.

↑ 2100 mm ↗ 400 mm → 3600 mm

Struttura mobile modulare componibile.
Struttura in nobilitato bianco o nero
e ante con finitura a scelta.

Mobile modular cabinet with a choice of
black/white laminated doors.

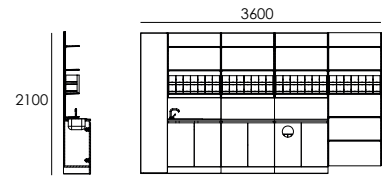
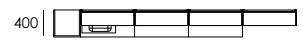

1 EASY M. BASIN 50833
↑ 80 cm ↗ 40 cm → 80 cm

3 EASY RECYCLE 50843
↑ 80 cm ↗ 40 cm → 80 cm

5 EASY M. NOOK 50812
↑ 198 cm ↗ 40 cm → 40 cm

2 EASY M. STANDARD 50823
↑ 80 cm ↗ 40 cm → 80 cm

4 EXPO ECO 3 50921
↑ 97 cm ↗ 23 cm → 80 cm

6 EXPO ECO 5 50931
↑ 198 cm ↗ 23 cm → 80 cm

7 ALVEOLARE P47852
↑ 27 cm ↗ 20 cm → 76 cm

STRUCTURE
Structure color / Colore struttura

NERO OPACO MATT BLACK	BIANCO OPACO MATT WHITE
--------------------------	----------------------------

EASY
Finiture ante / Door finishes

NERO OPACO MATT BLACK	GRIGIO OPACO MATT GREY
AVORIO OPACO MATT IVORY	BIANCO OPACO MATT WHITE

PLUS
Finiture ante / Door finishes

TALCO BIANCO WHITE TALC	TALCO NERO BLACK TALC	NERO BRILLANTE BRILLANT BLACK	GRIGIO SATINATO SATIN GREY	ENGADINA ENGADINE
BIANCO BRILLANTE BRILLANT WHITE	TRANCHE TRANCHE	PALISSANDRO ROSEWOOD	EBANO EBONY	GRIGIO CHIARO LIGHT GREY





WELCOME

PANDORA SLIM

63

51412MA

↑ 1050 mm ↗ 750 mm → 1400 mm

Reception struttura interna in nobilitato idrofugo bianco opaco, frontale in lamiera scomposto in 3 parti finitura bianco lucido. Cassetto con serratura, ripiani a giorno. Piano con illuminazione (opzionale).
Piano con illuminazione (opzionale).

Reception desk, internal structure in matt white water resistant veneer, metal front panel divided into 3 parts with glossy white finish. Lockable drawer, open shelves. Table top with lighting (optional).
Table top with lighting (optional).

RAL
9016

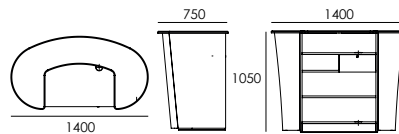

QUADRA

58101MA

↑ 1050 mm ↗ 520 mm → 1120 mm

Reception: struttura in nobilitato idrofugo
colore avorio o nero.

Frontale in lamiera verniciata a polvere
color avorio o nero.

Piano in mdf rivestito con foglia polimerica

Reception desk: structure in ivory or black
water repellent veneer.

Powder coated metal front panel.

MDF top covered with polymer paper.

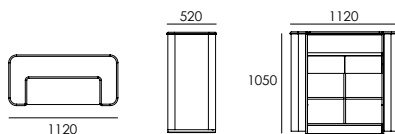

RAL
1015

RAL
9011





TT

1286MA

↑ 175 mm ↗ 215 mm → 360 mm

Appoggiapiedi.
Struttura base in alluminio fuso lucidato.
Appoggiapiedi in acciaio cromato.

Foot rests.
Base structure in polished cast aluminum.
Footrest in chromed steel.



GREAT

1808MA

↑ 850 mm ↗ 400 mm → 400 mm

Carrello di servizio con sei cassetti estraibili.
Struttura in polipropilene antimacchia.
Piano attrezzato con vani portaoggetti.
Montato su ruote piroettanti.

Service trolley with six pull-out drawers.
Stainproof polypropylene structure.
Surface equipped with accessory compartments.
Runs on castor wheels.

ONLY BLACK

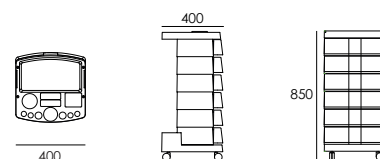



DETTAGLI TECNICI TECHNICAL DETAILS

EXPOBACK 1533

Mobile expo retro mensola
Back storage

BUTTERFLY O



BUTTERFLY M



BUTTERFLY B

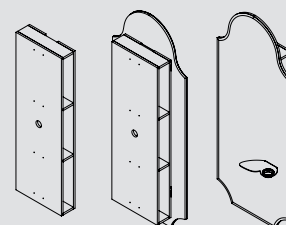
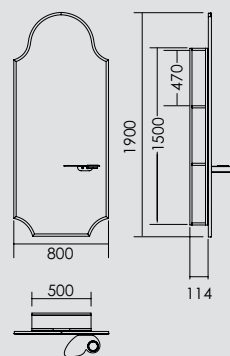
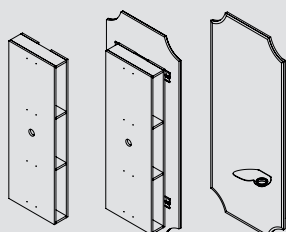
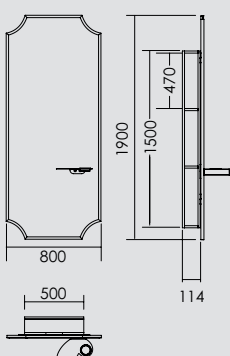
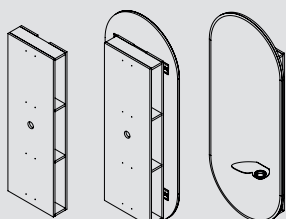
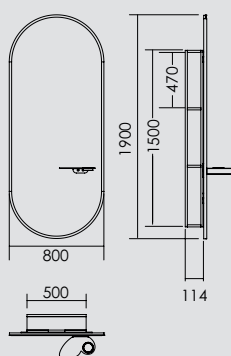

SKAY



MADAM STAR

3787

PIEDE A STELLA CON BASE IN ALLUMINIO LUCIDO E POMPA IDRAULICA GIREVOLE E FRENANTE

STAR-SHAPED FOOT WITH POLISHED ALUMINUM BASE AND ROTATING AND BRAKING HYDRAULIC PUMP

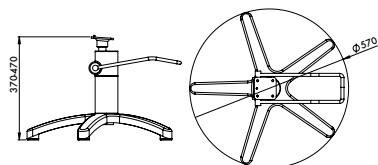

MADAM RONDE

3786

PIEDE TONDO CON BASAMENTO IN ACCIAIO CROMATO E POMPA IDRAULICA GIREVOLE E FRENANTE

ROUND FOOT WITH CHROMED STEEL BASE AND ROTATING AND BRAKING HYDRAULIC PUMP

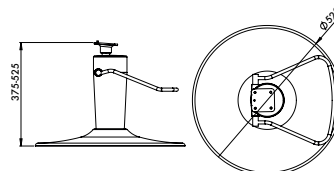

ECOSHOWER

ECOSHOWER1

doccetta
shower



SALCOL

SALCOL4510A

salvacollo
save neck



ALL IN ONE BOX GALA



GALA

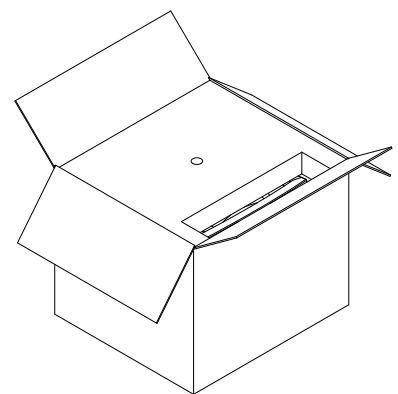
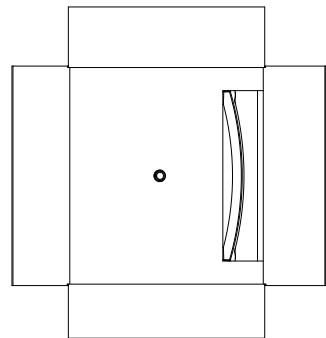
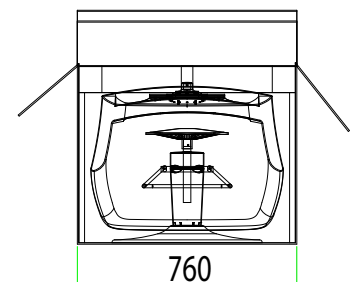
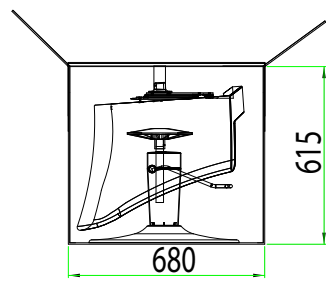
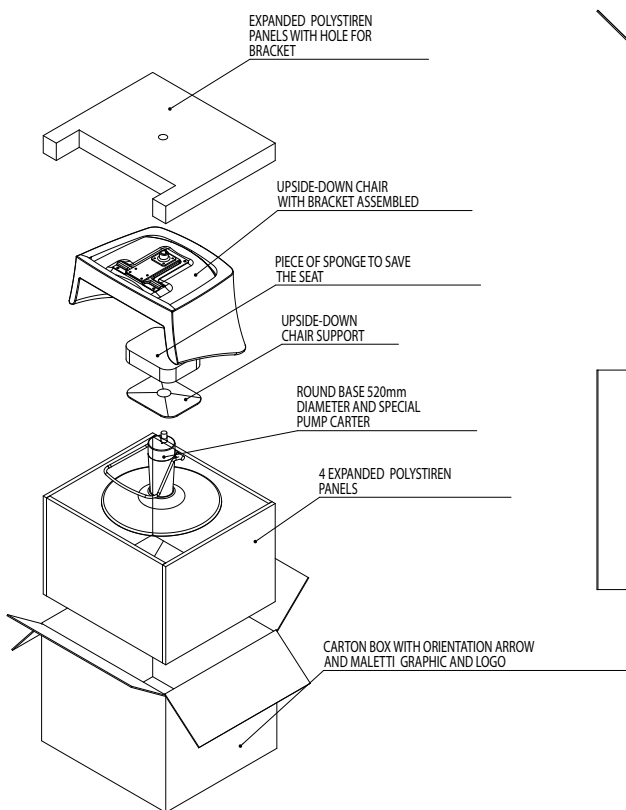
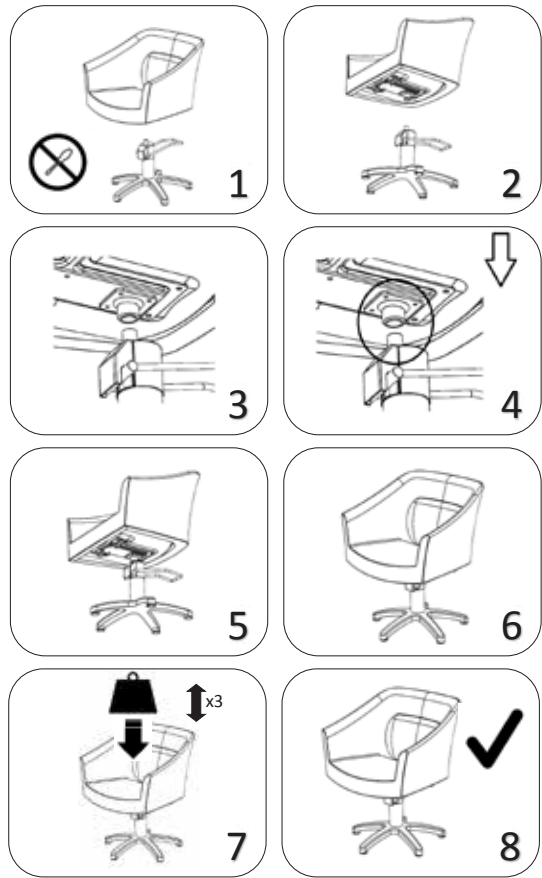

LADY + CARUSO / LADY + KATY / LADY + LION



008C	173C	585B	535B	563C
927C	918C	575B	921C	830B



POSIZIONE DA CONSIDERARE PER OTTENERE UNA DISTANZA = SPAZIO DI LAVORO PARI A 60 CM DAL RETROCODETTA AL MURO .

POSITION TO BE CONSIDERED TO OBTAIN A DISTANCE SAME AS THE WORKING SPACE EQUAL TO 60 CM FROM BACK BASIN TO WALL

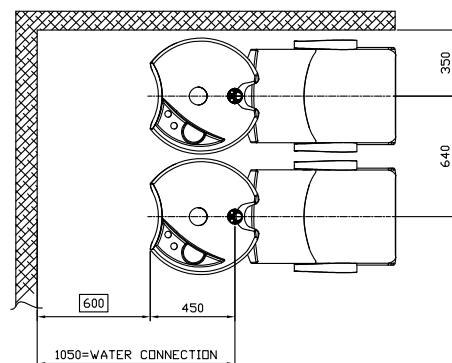
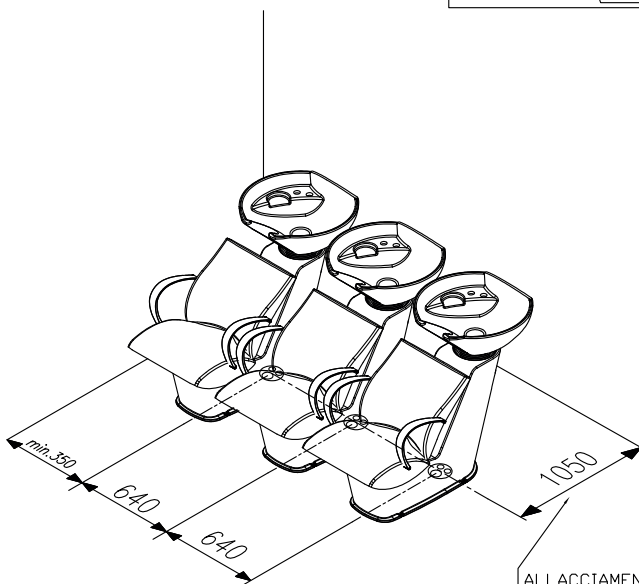
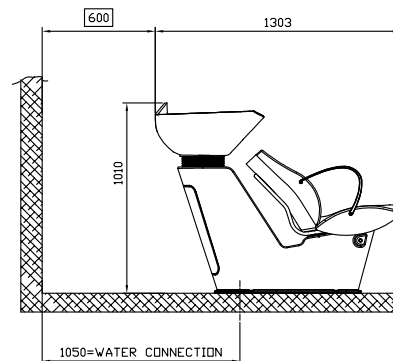
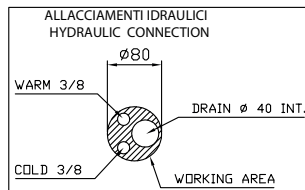

ALLACCIAMENTO IDRAULICO
HYDRAULIC CONNECTION

LADY + LION PLUS

POSIZIONE DA CONSIDERARE PER OTTENERE UNA DISTANZA = SPAZIO DI LAVORO PARI A 60 CM DAL RETROCODETTA AL MURO .
 POSITION TO BE CONSIDERED TO OBTAIN A DISTANCE SAME AS THE WORKING SPACE EQUAL TO 60 CM FROM BACK BASIN TO WALL

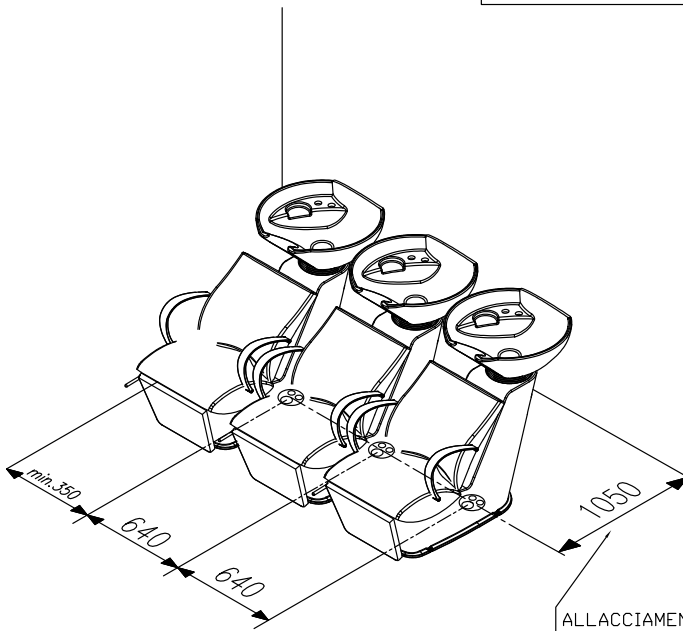
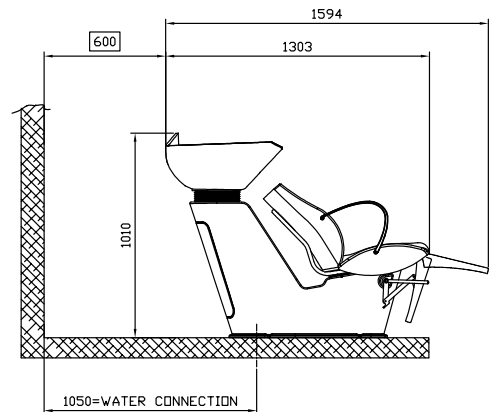
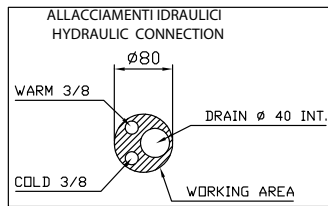

ALLACCIAMENTO IDRAULICO
HYDRAULIC CONNECTION

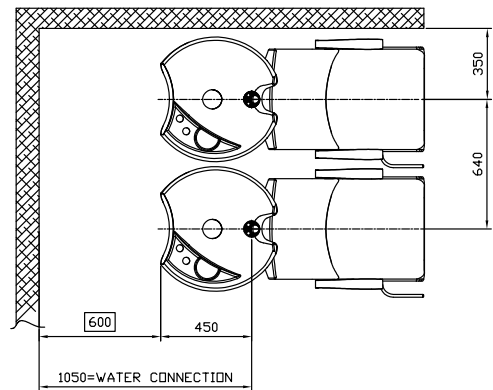

INFRALADY₆₄₀ / INFRALADY₇₀₀ + CARUSO - KATY - LION - LION PLUS

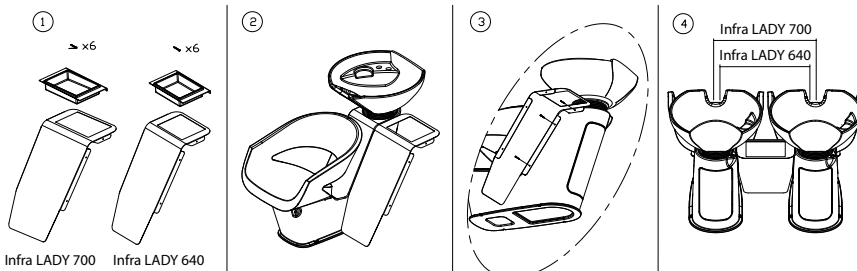

BAHAMAS

POSIZIONE DA CONSIDERARE PER OTTENERE UNA DISTANZA = SPAZIO DI LAVORO PARI A 60 CM DAL RETROCODETTA AL MURO.

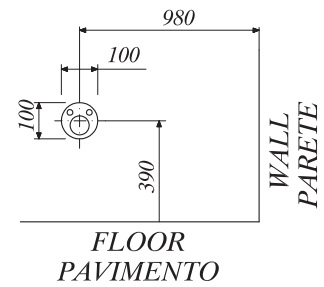
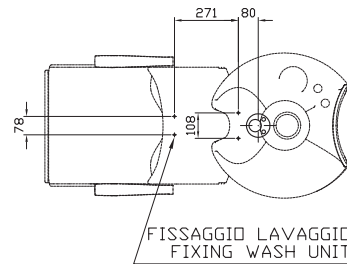
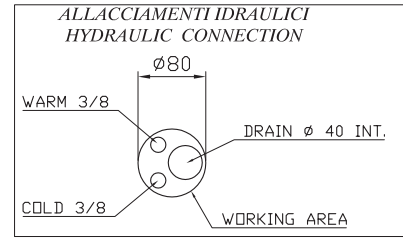
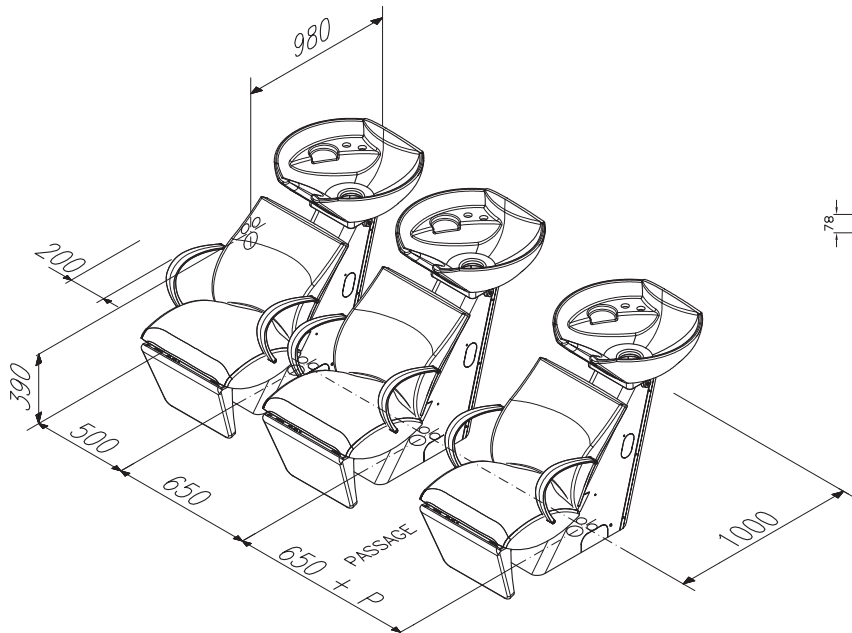

INFRABAHAMAS

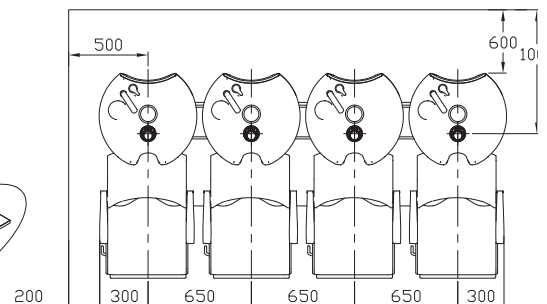
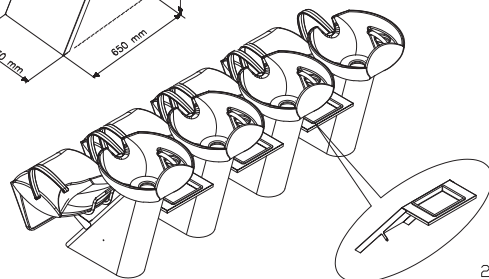
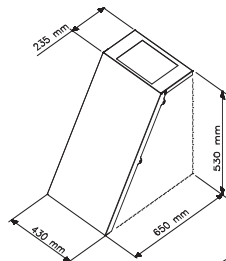
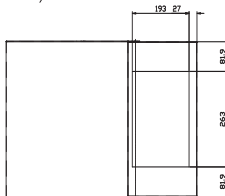
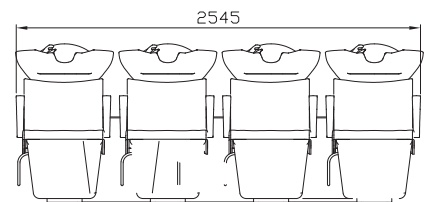
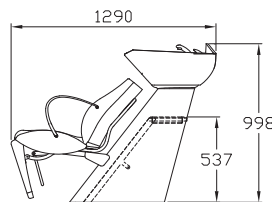
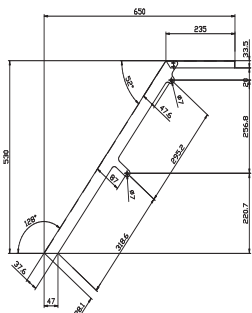

LAZZARO

POSIZIONE DA CONSIDERARE PER OTTENERE UNA DISTANZA = SPAZIO DI LAVORO PARI A 60 CM DAL RETROCODETTA AL MURO .

POSITION TO BE CONSIDERED TO OBTAIN A DISTANCE SAME AS THE WORKING SPACE EQUAL TO 60 CM FROM BACK BASIN TO WALL

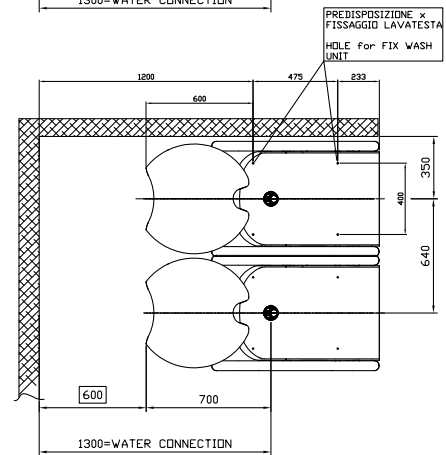
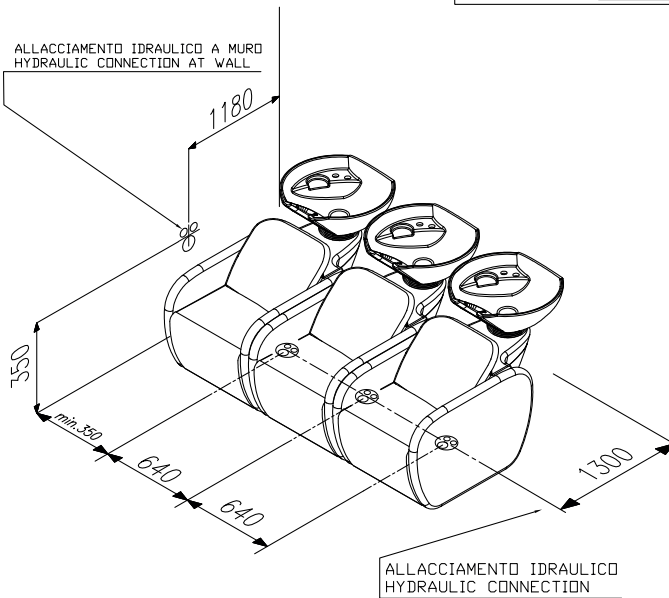
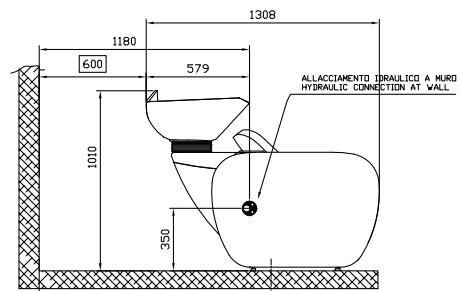
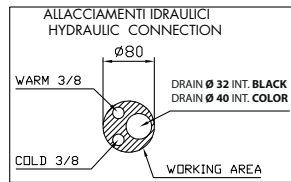

GONDOLA

POSIZIONE DA CONSIDERARE PER OTTENERE UNA DISTANZA = SPAZIO DI LAVORO PARI A 60 CM DAL RETROCODETTA AL MURO .

POSITION TO BE CONSIDERED TO OBTAIN A DISTANCE SAME AS THE WORKING SPACE EQUAL TO 60 CM FROM BACK BASIN TO WALL

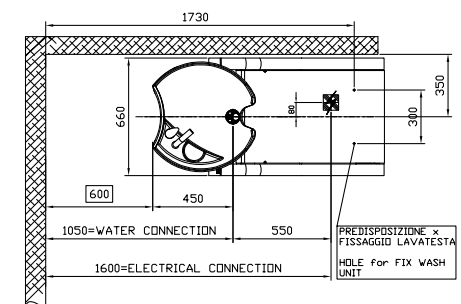
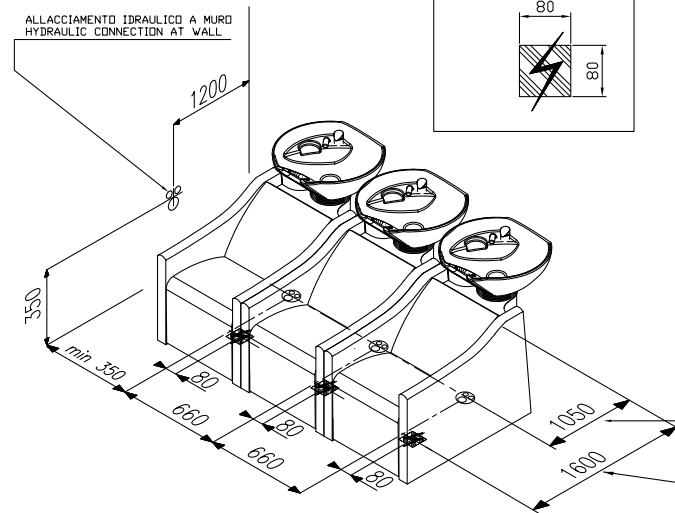
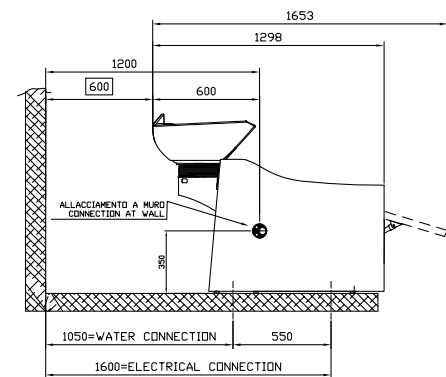
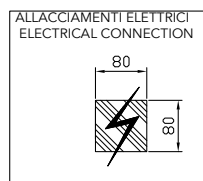
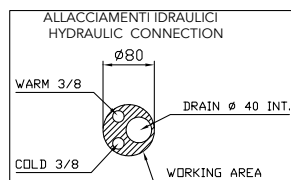

EASY M.

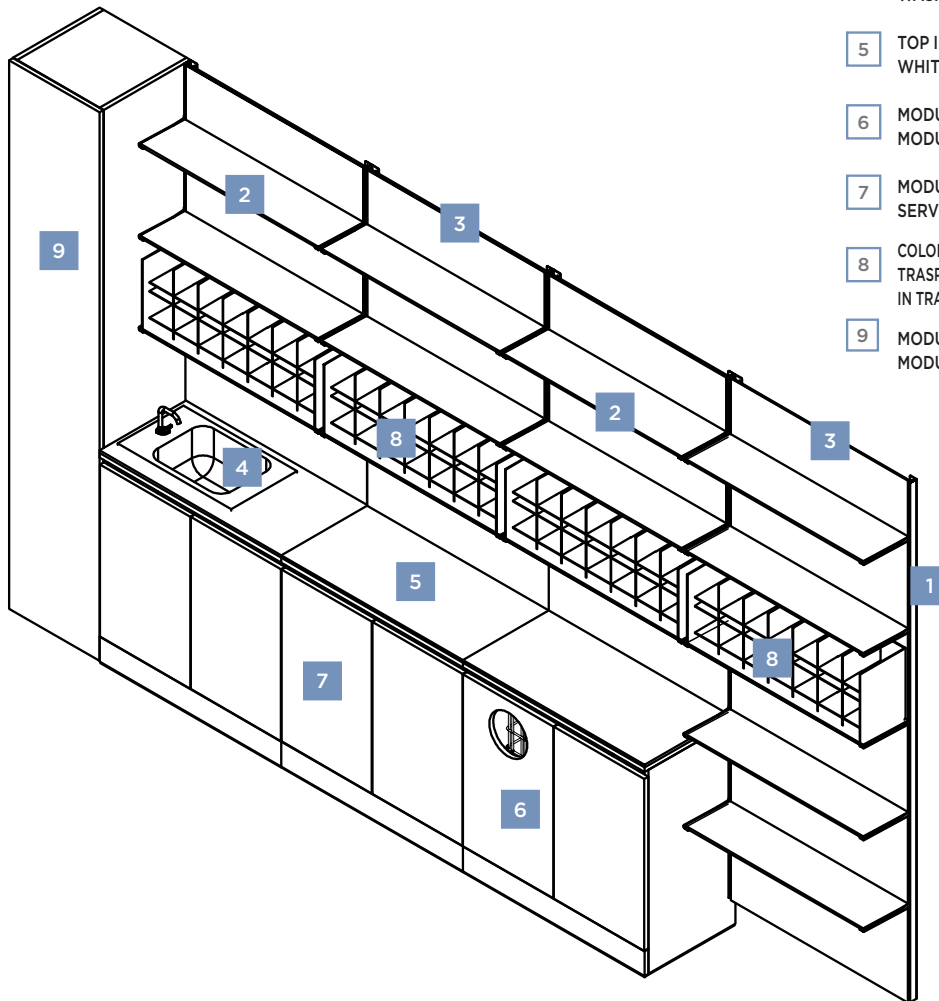
MOBILE RETROLAVAGGIO
BACK WASHES

- 1 STRUTTURA EXPO VERNICIATA BIANCO O NERO
STRUCTURE EXPO PAINTED BLACK OR WHITE
- 2 PIANI IN VETRO BIANCO, NERO O TRASPARENTE
TOPS IN WHITE, BLACK OR TRANSPARENT GLASS
- 3 EXPO IN METALLO BIANCO O NERO
PREDISPOSTO PER GRAFICHE MAGNETICHE
METAL EXPO BLACK OR WHITE
FOR MAGNETIC GRAPHICS
- 4 LAVABO INOX CON MISCELATORE CROMATO
WASHBASIN WITH CHROME MIXER
- 5 TOP IN VETRO SERIGRAFATO BIANCO O NERO
WHITE OR BLACK SERIGRAPHED GLASS TOP
- 6 MODULO PER RACCOLTA DIFFERENZIATA
MODULE FOR SEVERAL COLLECTION
- 7 MODULO SERVIZIO CON ANTE
SERVICE MODULE WITH DOORS
- 8 COLORBAR ALVEOLARE PORTATINTE IN PLEXIGLASS
TRASPARENTE / COLORBAR HONEYCOMB DYES
IN TRANSPARENT PLEXIGLASS
- 9 MODULO PORTASCOPE
MODULE BROOM HOLDER

STRUCTURE

Structure color / Colore struttura

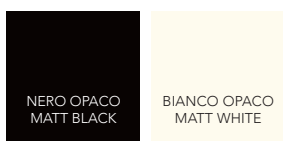

EASY

Finiture ante / Door finishes



PLUS

Finiture ante / Door finishes

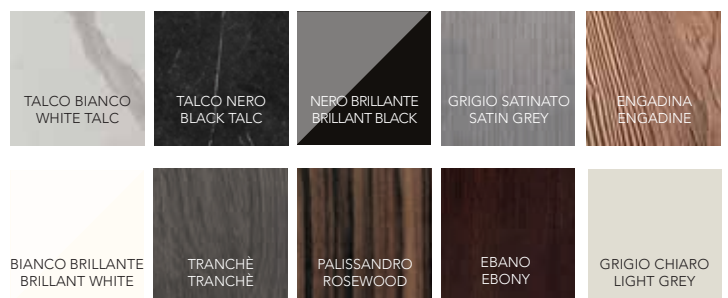

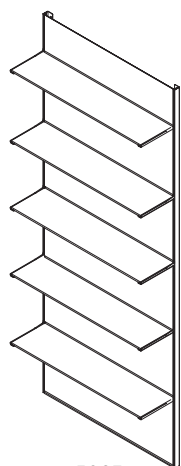

1
5093
EXPO ECO H 198 METAL 80
EXPO ECO H 198 METAL 80
↑ 1980 mm ↗ 230 mm → 800 mm

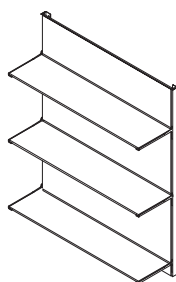

3
5092
EXPO ECO
RETROLAVATESTA METAL 80
ECO EXPO
RETROWASH METAL 80
↑ 970 mm ↗ 230 mm → 800 mm

1 STRUTTURA EXPO 5
EXPO 5 STRUCTURE

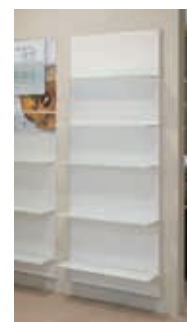

1 3 STRUTTURA MAGNETICA PER GRAFICA
MAGNETIC STRUCTURE FOR GRAPHICS

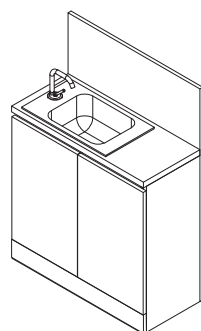

4
50832
MODULO LAVABO 80
WASHBASIN MODULE
↑ 1130 mm ↗ 400 mm → 800 mm

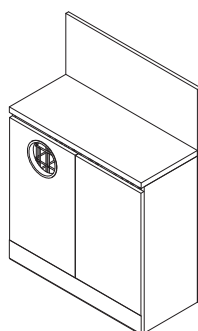

6
50842
MODULO RECICLO 80
RECYCLING MODULE 80
↑ 1130 mm ↗ 400 mm → 800 mm

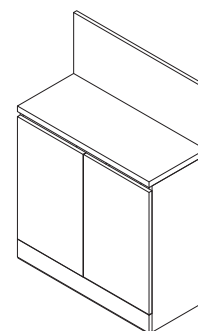

7
50822
MODULO LISCILO 80
SMOOTH MODULE 80
↑ 1130 mm ↗ 400 mm → 800 mm

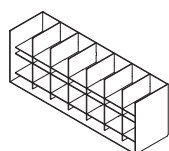

8
P47852
COLOR BAR - ALVEOLARE PORTATINTE PLEXIGLASS TRASPARENTE
COLOR BAR - HONEYCOMB DYES IN TRANSPARENT PLEXIGLASS
↑ 270 mm ↗ 200 mm → 760 mm

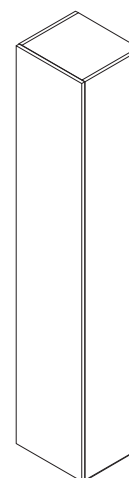

9
50812
MODULO PORTASCOPE
MODULE BROOM HOLDER
↑ 2100 mm ↗ 400 mm → 400 mm



BARBER STATION



- | | | | |
|----|--|----|---|
| 1 | STRUTTURA IN NOBILITATO IDROFUGO | 1 | FACILITY STRUCTURE WATERPROOF |
| 2 | SPECCHIO AGGANCIATO SU PANNELLO IN NOBILITATO | 2 | ATTACHED MIRROR ON PANEL ENHANCED |
| 3 | PANNELLO CON RIPIANI PER EXPO PRODOTTI IN NOBILITATO | 3 | PANEL WITH SHELVES FOR EXPO PRODUCTS IN LAKE |
| 4 | LAVABO IN RESINA BIANCO/NERO | 4 | BLACK OR WHITE RESIN WASHBASIN |
| 5 | TOP IN VETRO EXTRACHIARO SERIGRAFATO BIANCO/NERO | 5 | EXTRACHIAR GLASS TOP SERIGRAPHED WHITE OR BLACK |
| 6 | VANO A GIORNO CON RIPIANO AMOVIBILE PER STERILIZZATORE | 6 | COMPARTMENT DAY WITH SHELF REMOVABLE FOR STERILIZER |
| 7 | CASSETTO SU GUIDE A RULLI | 7 | DRAWER ON ROLLER GUIDES |
| 8 | ANTA APRIBILE | 8 | OPENING DOOR |
| 9 | CAPPELLO | 9 | HAT |
| 10 | FASCIA TAMPONE | 10 | BUFFER STRIP |

FINITURE DI RIVESTIMENTO
 COATING FINISHES

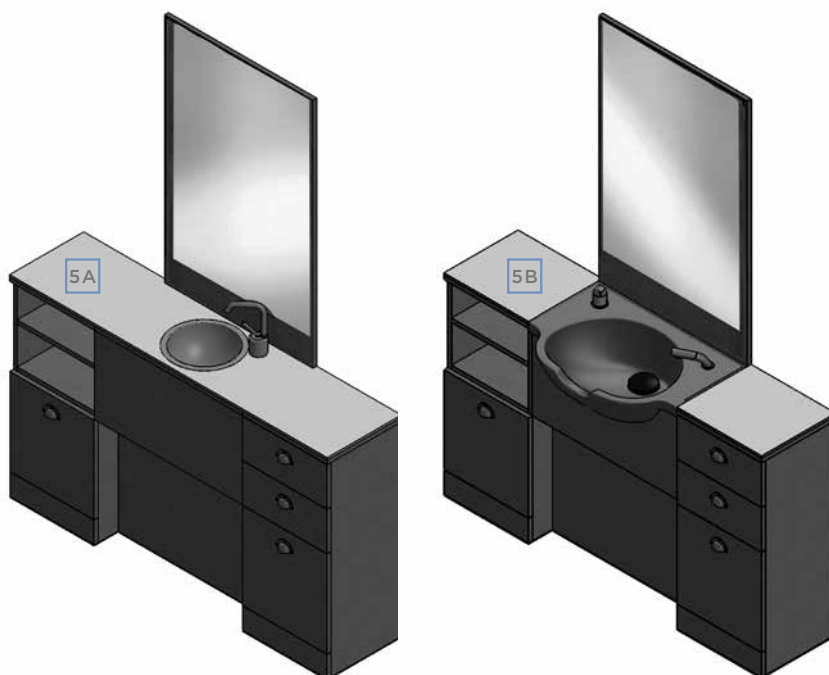
 Lavabo bianco o nero
 White or black washbasin



3 P43451BOI
PANNELLO BOISERIE
WOOD PANEL PANEL
↑ 1090 mm ↗ 50 mm → 400 mm
ENGANDINE / SEQUOIA



3 P43451EXP
PANNELLO EXPO
EXPO PANEL
↑ 1090 mm ↗ 170 mm → 400 mm
ENGANDINE / SEQUOIA



2 P43451SPE
GRUPPO SPECCHIERA
MIRROR UNIT
↑ 1090 mm ↗ 30 mm → 700 mm
ENGANDINE / SEQUOIA



9 P43451CAP
CAPPELLO
HAT
→ 1500 mm
ENGANDINE / SEQUOIA



10 P43451FAS
FASCIA TAMPONE
BUFFER STRIP
↑ 208 mm ↗ 18 mm → 698 mm
ENGANDINE / SEQUOIA



4 P43451FIX
MOBILE A LAVABO FISSO
FIX WASHBASIN CABINET WHITE
↑ 910 mm ↗ 500 mm → 700 mm
ENGANDINE / SEQUOIA



4 P43451FIX
MOBILE A LAVABO FISSO
FIX WASHBASIN CABINET BLACK
↑ 910 mm ↗ 500 mm → 700 mm
ENGANDINE / SEQUOIA



4 P43451EASY
MOBILE A LAVABO
WASHBASIN CABINET
↑ 910 mm ↗ 350 mm → 700 mm
ENGANDINE / SEQUOIA



1 **10** P43451EASYM
MOBILE SENZA LAVABO
CABINET WITHOUT WASHBASIN
↑ 910 mm ↗ 350 mm → 700 mm
ENGANDINE / SEQUOIA



8 **6** P43451ACC
MOBILE A GIORNO
CABINET FOR DAY
↑ 900 mm ↗ 350 mm → 400 mm
ENGANDINE / SEQUOIA



8 **7** P43451CAS
MOBILE CON CASSETTI
CABINET WITH DRAWERS
↑ 900 mm ↗ 350 mm → 400 mm
ENGANDINE / SEQUOIA



5A P43451TOP2
SALVA PIANO IN VETRO/GLASS TOP
SAVER GLASS PLAN PROTECTION
↑ 10 mm ↗ 350 mm → 1500 mm
BIANCO / NERO - BLACK / WHITE



5B P43451TOP
SALVA PIANO IN VETRO/GLASS TOP
SAVER GLASS PLAN PROTECTION
↑ 10 mm ↗ 350 mm → 400 mm
BIANCO / NERO - BLACK / WHITE

ITA 1- definizioni

Il Cliente: la persona fisica o giuridica che agisce nell'esercizio della propria attività imprenditoriale, commerciale, artigianale o professionale, ovvero un suo intermediario che acquista i Prodotti commercializzati da Maletti Group Spa con sede in P.-Le G. Maletti n.1, 42019 Scandiano (RE) - Italia, che vende i Prodotti.

Conferma d'Ordine: avviso scritto di conferma del Prodotto ordinato, inviato al Cliente da Maletti Group Spa

Prezzo: quello indicato nella Conferma d'Ordine.

Prodotto/i: quello/i indicato/i nella Conferma d'Ordine.

Contratto: quello concluso tra Maletti Group Spa e Cliente a mezzo scambio di Ordine e Conferma d'Ordine, regolato dalle presenti condizioni generali di vendita e di garanzia.

2- Efficacia_ Il presente Contratto si applica alla presente vendita e ad ogni successiva intercorsa tra Maletti Group Spa ed il Cliente, fatta salva la successiva sottoscrizione di altre e differenti condizioni di vendita e di garanzia. L'invio di un ordine implica accettazione del Contratto.

3- Ordini_Gli ordini si accettano per iscritto (posta elettronica e fax sono assimilati) e divengono vincolanti per Maletti Group Spa e tra le parti quando Maletti Group Spa invia al Cliente la Conferma d'Ordine. La Conferma d'Ordine deve essere controllata immediatamente dal Cliente che deve comunicare prontamente per iscritto a Maletti Group Spa qualsiasi errore riscontrato. In mancanza, decorsi tre giorni, le indicazioni contenute nella Conferma d'Ordine si applicheranno al Contratto.

Non sarà accettato alcun ordine se non accompagnato dalle presenti condizioni generali di vendita e di garanzia sottoscritte dal Cliente.

Gli ordini successivi, accettati e confermati da Maletti Group Spa a mezzo Conferma d'Ordine, rimangono soggetti al presente Contratto.

4- Prezzo e termini di pagamento_ I preventivi di Maletti Group Spa sono validi solo se redatti per iscritto e per il periodo in essi indicato. Il Prezzo include esclusivamente i beni e le prestazioni elencate e deve comunque intendersi al netto di IVA. Il pagamento dovrà avvenire nei modi e nei tempi indicati nella Conferma d'Ordine.

Maletti Group Spa può sospendere la consegna o l'esecuzione dell'Ordine fino all'aver avuto pagamento dello stesso, se è concordato il pagamento anticipato, o di ogni altra precedente transazione nella quale il Cliente sia in ritardo con i pagamenti.

Il Cliente rinuncia fin da ora a qualsivoglia eccezione di compensazione tra le somme da esso dovute a Maletti Group Spa ed ogni altra somma di cui esso risultasse o si asserisse creditore, a qualsivoglia titolo, anche se liquida ed esigibile, anche se non contestata e legalmente esigibile.

In caso di ritardo nel pagamento, il Cliente dovrà corrispondere gli interessi di cui al D.Lgs. n.231/2002 sulla somma ancora dovuta, nonché i costi per il recupero della stessa, senza necessità di formale messa in mora.

5- Consegna / Titolo / Rischio_ Il termine di consegna indicato nella Conferma d'Ordine è indicativo. Sono ammesse consegne parziali. Il luogo di consegna è indicato nella Conferma d'Ordine.

La merce viaggia ad esclusivo rischio e pericolo del compratore, anche se venduta porto franco. La proprietà del Prodotto passa solo all'aver avuto pagamento dell'intero prezzo. Fatto salvo quanto previsto dall'Articolo 1525 del Codice Civile, Maletti Group Spa potrà (senza responsabilità verso il Cliente) rientrare in possesso del Prodotto. Maletti Group Spa potrà agire in giudizio per conseguire il Prezzo anche prima del passaggio della proprietà. Qualora il Cliente rifiuti la consegna senza previo accordo con Maletti Group Spa, resteranno a suo carico le spese o le perdite sostenute da Maletti Group Spa a causa di tale rifiuto, incluse le spese di deposito fino all'accettazione della consegna.

6- Accettazione_ Alla consegna del Prodotto, il Cliente deve controllarlo e ispezionarlo e, se del caso, rifiutarlo o denunciare eventuali vizi entro e non oltre 8 giorni dalla consegna.

Alla scadenza di tale termine il Prodotto si riterrà accettato dal Cliente. Maletti Group Spa acconsente a propria discrezione alla restituzione del Prodotto, questo dovrà essere restituito nelle sue condizioni originali, con relativo imballo, con una nota di restituzione e con la prova dell'aver avuto acquisto; i costi di restituzione saranno a carico del Cliente.

7- Responsabilità_ Maletti Group Spa non sarà in alcun modo responsabile per danni diretti od indiretti o perdite consequenziali in caso di mancato o cattivo funzionamento dei Prodotti, per perdita di affari, profitti, stipendi, compensi, risparmi, salvo quanto previsto dalle garanzie di legge o quanto previsto nelle presenti condizioni generali.

Maletti Group Spa non sarà parimenti responsabile di danni provocati durante l'installazione dei Prodotti a pavimenti, mobilio, suppellettili, arredamento, e quant'altro presente nei locali, riconoscendo il Cliente di avere il preciso obbligo contrattuale di provvedere alla preventiva protezione o allo spostamento degli stessi.

Il Cliente riconosce di essere stato preventivamente avvertito da Maletti Group Spa degli interventi necessari alla installazione dei Prodotti, in particolare delle modalità e delle caratteristiche degli stessi.

8- Forza Maggiore_ Maletti Group Spa non sarà responsabile del ritardo nell'adempimento delle sue obbligazioni (incluso il ritardo nella consegna) se tale ritardo sia causato da circostanze al di fuori del suo ragionevole controllo e avrà diritto a fruire di un'estensione temporale per l'adempimento; esempi di eventi di forza maggiore includono scioperi, problemi per la fornitura/trasporto/fabbricazione, oscillazioni dei tassi di cambio, azioni governative o regolamentari, catastrofi naturali. Se l'evento di forza maggiore persiste per un periodo superiore a 2 mesi, ciascuna delle Parti avrà diritto di recedere dal Contratto, senza che alcun risarcimento sia dovuto alla controparte.

9- Protezione Dati Personali_ Maletti Group Spa I dati personali del Cliente saranno trattati, conservati e/o comunicati come per legge ed il Cliente vi acconsente sin d'ora ai sensi ed agli effetti della normativa in vigore sulla tutela della Privacy. Il Cliente potrà esercitare i diritti di accesso, correzione, cancellazione e blocco del trattamento dei suoi dati inviando lettera a Maletti Group Spa Il Cliente potrà imporre a Maletti Group Spa di non utilizzare i suoi dati a scopi di marketing.

10- Garanzia

10.1. Ambito di operatività_ La presente garanzia è destinata ai Clienti operanti nell'ambito della propria attività professionale, secondo la definizione dell'articolo 1. Le vendite di cui alle presenti condizioni generali sono relative a Prodotti non destinati ai consumatori, quali individuati dall'articolo 3 del D.Lgs.206/2005. La garanzia riguarda i vizi dei Prodotti, intendendosi come tali le imperfezioni materiali della cosa, tali da incidere in modo rilevante sulla sua utilizzabilità o sul suo valore, relative ad anomalie del processo di produzione, di fabbricazione, di formazione, di conservazione, ed è operante nei limiti e secondo le condizioni di seguito elencate.

10.2- Durata_ Maletti Group Spa garantisce i Prodotti per un anno dalla data di consegna.

10.3 Quando si applica_ Fatte salve le precisazioni, le esclusioni o le limitazioni di seguito indicate, o comunque richiamate in questo contratto, la garanzia si applica ai vizi dei Prodotti, quali individuati secondo la definizione dell'art.1490 1° comma del codice civile.

10.4- Modalità, termini e decadenze per far valere il diritto alla garanzia_ Alla scoperta del vizio il Cliente è tenuto a darne comunicazione scritta a Maletti Group Spa, allegando copia della fattura di vendita e della Conferma d'Ordine di riferimento ed indicando il numero di serie (serial number) del bene viziato. La comunicazione deve pervenire per iscritto a Maletti Group Spa entro otto giorni dalla scoperta, a pena di decadenza del diritto alla garanzia. Il diritto alla garanzia si prescrive in un anno.

Ogni intervento del Cliente o di terzi sul Prodotto viziato, se non autorizzato per iscritto da Maletti Group Spa, costituisce motivo di decadenza della garanzia.

10.5- Esclusioni e limitazioni_ Fatto salvo quanto altrove specificato, la garanzia è esclusa se il vizio è provocato o accentuato da un uso non conforme del Prodotto da parte del Cliente o di terzi, ovvero da una manutenzione non conforme alle indicazioni del produttore, o da interventi di qualunque natura, anche manutentiva, sullo stesso non effettuati o non autorizzati da Maletti Group Spa.

La garanzia è inoltre esclusa:

- se alla comunicazione di denuncia del vizio non sono allegati i documenti e non sono fornite le informazioni previste dall'art.10.4;

- se i Prodotti sono stati installati, conservati o stoccati in ambienti inadeguati a tutelarne la qualità (quali ambienti esterni, umidi, scarsamente areati, molto caldi o molto freddi);

- se i Prodotti non sono stati montati in modo corretto, o risultano manomessi, integrati con parti e componenti non originali o non autorizzati da Maletti Group Spa, puliti con procedure o prodotti idonei a danneggiarli;

- in caso di danni che non derivano da originari vizi di produzione e/o dalla cattiva qualità dei materiali utilizzati ma che sono conseguenza di fatti o eventi traumatici per il prodotto quali si citano, a mero titolo esemplificativo e non esaustivo: urti, ammaccature, graffi, tagli, macchie causate da fattori esterni quali tinture, lacche prodotti per la pulizia;

- per i danni da usura data dal normale uso dei Prodotti;

- se i prodotti non sono utilizzati dai soggetti ai quali sono destinati e per i quali sono prodotti, cioè parrucchieri, estetisti, saloni di bellezza, beauty farms, terme, studi medici.

10.6- Condizioni particolari di garanzia

Vigono le seguenti condizioni particolari di garanzia a seconda del componente o del materiale di seguito indicato: Pompe: Vengono garantite due anni dalla data di consegna.

MADAM è una linea MALETTI GROUP

Le foto sono destinate a mostrare i prodotti in un ambiente ideale. Maletti Group si riserva il diritto di apportare modifiche ai suoi prodotti della linea MADAM.

ENG 1- definitions

The Customer: the natural or legal person who acts in the exercise of his entrepreneurial, commercial, artisanal or professional activity, or an intermediary who buys the Products marketed by Maletti Group Spa based in P.- Le G. Maletti n.1 , 42019 Scandiano (RE) - Italy, which sells the Products.

Order Confirmation: written confirmation of the ordered Product, sent to the Customer by Maletti Group Spa

Price: the one indicated in the Order Confirmation.

Product (s): that (s) indicated in the Order Confirmation.

Contract: the one concluded between Maletti Group Spa and the Customer by means of an exchange of the Order and Order Confirmation, governed by these general conditions of sale and warranty.

2- Effectiveness_ This Agreement applies to this sale and to any subsequent one between Maletti Group Spa and the Customer, without prejudice to the subsequent signing of other and different conditions of sale and warranty. Sending an order implies acceptance of the Contract.

3- Orders_ Orders are accepted in writing (e-mail and fax are assimilated) and become binding for Maletti Group Spa and between the parties when Maletti Group Spa sends the Order Confirmation to the Customer. The Order Confirmation must be checked immediately by the Customer who must promptly notify Maletti Group Spa in writing of any errors found. Failing that, after three days, the indications contained in the Order Confirmation will apply to the Contract.

The following special warranty conditions apply depending on the component or material indicated below: Pumps: They are guaranteed for two years from the date of delivery.

No order will be accepted unless accompanied by these general conditions of sale and warranty signed by the Customer.

Subsequent orders, accepted and confirmed by Maletti Group Spa by means of an Order Confirmation, remain subject to this Agreement.

4- Price and terms of payment_ Maletti Group Spa's estimates are valid only if drawn up in writing and for the period indicated therein. The Price includes only the goods and services listed and must in any case be understood as net of VAT. Payment must be made in the manner and within the times indicated in the Order Confirmation.

Maletti Group Spa may suspend the delivery or execution of the Order until payment is made, if advance payment is agreed, or any other previous transaction in which the Customer is late with payments.

The Customer renounces as of now any exception of compensation between the sums owed by him to Maletti Group Spa and any other sum of which he is or is alleged to be a creditor, for any reason, even if liquid and payable, even if not contested and legally due.

In case of delay in payment, the Customer must pay the interest referred to in Legislative Decree 231/2002 on the amount still due, as well as the costs for its recovery, without the need for formal notice.

5- Delivery / Title / Risk_ The delivery time indicated in the Order Confirmation is indicative. Partial deliveries are allowed. The place of delivery is indicated in the Order Confirmation.

The goods travel at the sole risk and peril of the buyer, even if sold carriage paid. Ownership of the Product passes only upon payment of the full price. Without prejudice to the provisions of Article 1525 of the Civil Code, Maletti Group Spa may (without liability to the Customer) regain possession of the Product. Maletti Group Spa may take legal action to obtain the Price even before the transfer of ownership. If the Customer refuses the delivery without prior agreement with Maletti Group Spa, the expenses or losses incurred by Maletti Group Spa due to such refusal will remain at their expense, including storage costs until the delivery is accepted.

6- Acceptance_ Upon delivery of the Product, the Customer must check and inspect it and, if necessary, refuse it or report any defects within and no later than 8 days from delivery.

Upon expiry of this term, the Product will be deemed accepted by the Customer. Maletti Group Spa agrees at its discretion to return the Product, it must be returned in its original condition, with its packaging, with a return note and with proof of purchase; the return costs will be charged to the customer.

7- Responsibility_ Maletti Group Spa will not be liable in any way for direct or indirect damages or consequential losses in the event of failure or malfunction of the Products, for loss of business, profits, salaries, compensation, savings, except as provided by the legal guarantees or as provided in these general conditions.

Maletti Group Spa will also not be responsible for damage caused during the installation of the Products on floors, furniture, furnishings, and anything else present in the premises, acknowledging the Customer that he has the precise contractual obligation to provide for the preventive protection or to move of the same.

The Customer acknowledges that he has been warned in advance by Maletti Group Spa of the interventions necessary for the installation of the Products, in particular of the methods and characteristics of the same.

8- Force Majeure_ Maletti Group Spa will not be responsible for the delay in the fulfillment of its obligations (including the delay in delivery) if this delay is caused by circumstances beyond its reasonable control and will be entitled to benefit from a time extension for fulfillment; examples of force majeure events include strikes, supply / transportation / manufacturing problems, exchange rate fluctuations, governmental or regulatory actions, natural disasters. If the force majeure event persists for a period exceeding 2 months, each of the Parties will have the right to withdraw from the Contract, without any compensation being due to the other party.

9- Personal Data Protection_ Maletti Group Spa The Customer's personal data will be processed, stored and / or disclosed as required by law and the Customer hereby agrees to it pursuant to and for the purposes of the legislation in force on the protection of privacy. The Customer may exercise the rights of access, correction, cancellation and blocking of the processing of his data by sending a letter to Maletti Group Spa. The Customer may require Maletti Group Spa not to use his data for marketing purposes.

10- Warranty

10.1. Scope of operation_ This warranty is intended for Customers operating in the context of their professional activity, according to the definition of article 1. The sales referred to in these general conditions relate to Products not intended for consumers, as identified by article 3 of Legislative Decree 206/2005. The warranty concerns the defects of the Products, meaning material imperfections of the thing, such as to significantly affect its usability or its value, related to anomalies in the production process, manufacturing, training, conservation, and is operating within the limits and under the conditions listed below.

10.2- Duration_ Maletti Group Spa guarantees the Products for one year from the delivery date.

10.3 When it applies_ Without prejudice to the clarifications, exclusions or limitations indicated below, or otherwise referred to in this contract, the warranty applies to defects in the Products, as identified according to the definition of Article 1490, 1st paragraph of the Civil Code.

10.4- Methods, terms and forfeits to assert the right to the guarantee_ On discovering the defect, the Customer is required to notify Maletti Group Spa in writing, attaching a copy of the sales invoice and the reference Order Confirmation and indicating the series (serial number) of the spoiled property. The communication must be received in writing by Maletti Group Spa within eight days of discovery, under penalty of forfeiture of the right to the guarantee. The right to the guarantee expires in one year.

Any intervention by the Customer or third parties on the defective Product, if not authorized in writing by Maletti Group Spa, constitutes a reason for forfeiture of the guarantee.

10.5- Exclusions and limitations_ Except as otherwise specified, the guarantee is excluded if the defect is caused or accentuated by a non-compliant use of the Product by the Customer or third parties, or by maintenance that does not comply with the manufacturer's instructions, or by interventions of any nature, including maintenance, not carried out or authorized by Maletti Group Spa.

The warranty is also excluded:

- if the documents are not attached to the notification of the defect and the information required by Article 10.4 is not provided;
- if the Products have been installed, stored or stored in environments unsuitable to protect their quality (such as external, humid, poorly ventilated, very hot or very cold environments);
- if the Products have not been assembled correctly, or are tampered with, integrated with parts and components that are not original or not authorized by Maletti Group Spa, cleaned with procedures or products capable of damaging them;
- in case of damages that do not derive from original production defects and / or from the poor quality of the materials used but which are the consequence of traumatic facts or events for the product such as, by way of example and not limited to: bumps, dents, scratches, cuts, stains caused by external factors such as dyes, lacquers, cleaning products;
- for wear and tear caused by normal use of the Products;
- if the products are not used by the subjects for whom they are intended and for which they are produced, i.e. hairdressers, beauticians, beauty salons, beauty farms, spas, medical offices.

10.6- Special warranty conditions

The following special warranty conditions apply depending on the component or material indicated below: Pumps: They are guaranteed for two years from the date of delivery.

MADAM is a MALETTI GROUP line

The photos are intended to show products in an ideal environment. Maletti Group reserves the right to make changes to its MADAM line products.

MADAM
MALETTIDESIGN

seguimi
follow me



www.madam.maletti.it

